

### Terminology Index

#### Terminology Index

ACCU-TRAK.....	2	Junk.....	9
Alkaline Battery .....	2	Lithium-ion battery (Li-ion battery).....	10
All metal .....	2	Monoloop coil .....	10
Amplifier.....	2	Multi-frequency .....	10
Analogue .....	2	Multi Period Sensing (MPS).....	10
Auto tune.....	2	Nickel cadmium battery (NiCd).....	10
Broad Band Spectrum (BBS).....	2	Nickel metal hydride battery (NiMH) .....	11
Coin, jewellery & relic hunting .....	2	Noise Cancel.....	11
Concentric coil .....	3	Non-ferrous .....	11
Conductivity .....	3	Notch Filter Discrimination.....	11
CO .....	3	Ohm.....	11
Continuous wave .....	3	Period.....	11
Control box.....	3	Pinpointing.....	11
Current.....	3	Pulse Induction (PI).....	11
Depth .....	3	QuickMask.....	12
Digital.....	3	Receive (Rx).....	12
Discrimination.....	4	Resistance .....	12
Discrimination pattern.....	4	Sealed lead acid battery (SLA) .....	12
Detectorist.....	4	Search Coil (loop) .....	12
Double-D coil (DD) .....	4	Sensitivity.....	12
Dual Voltage Technology (DVT).....	5	SETA.....	12
Eddy currents .....	5	Signal .....	13
Environmental noise.....	5	Sine wave .....	13
Electromagnetic field .....	5	Smartfind Discrimination .....	13
Falsing.....	5	Square Wave.....	14
Ferrous (Fe).....	5	Target.....	14
FE .....	6	Target ID number .....	14
Frequency.....	6	Threshold .....	15
Frequency domain .....	7	Time constant.....	15
Full Band Spectrum (FBS).....	7	Time domain .....	16
Gold prospecting .....	8	Timings.....	16
Ground balance .....	8	Tone identification.....	16
Ground mineralisation .....	8	Transmit (Tx) .....	16
Ground noise.....	8	Trashy ground.....	16
Ground tracking .....	8	Universal Serial Bus (USB) port .....	17
Halo effect .....	8	VFLEX .....	17
Harmonic frequencies (harmonics).....	9	VLF (Very low frequency).....	17
Hot rocks .....	9	Voltage .....	17
Iron Mask.....	9		

## ACCU-TRAK

ACCU-TRAK is the ground tracking technology used in the Eureka Gold metal detector.

## Alkaline Battery

Alkaline batteries are non-rechargeable batteries. They are available in common battery sizes such as AA, C & D and have a voltage of 1.5 volts per cell. These are the most commonly available battery.

## All metal

All metal refers to operating a metal detector without any metals being masked or discriminated. All metals will be detected regardless of ferrous or conductive properties.

## Amplifier

An Amplifier is a device or electronic circuit that increases amplitude (strength) of an electrical signal. The signal can be either an audio signal (sound) or a radio signal (electromagnetic).

## Analogue

Analogue refers to a method of transmitting and receiving data between electronic devices or within an electronic circuit. Analogue signals contain information in their amplitude (i.e. 2.83 volts) at a point in time or over a period of time. (Also see "Digital" on page 3)

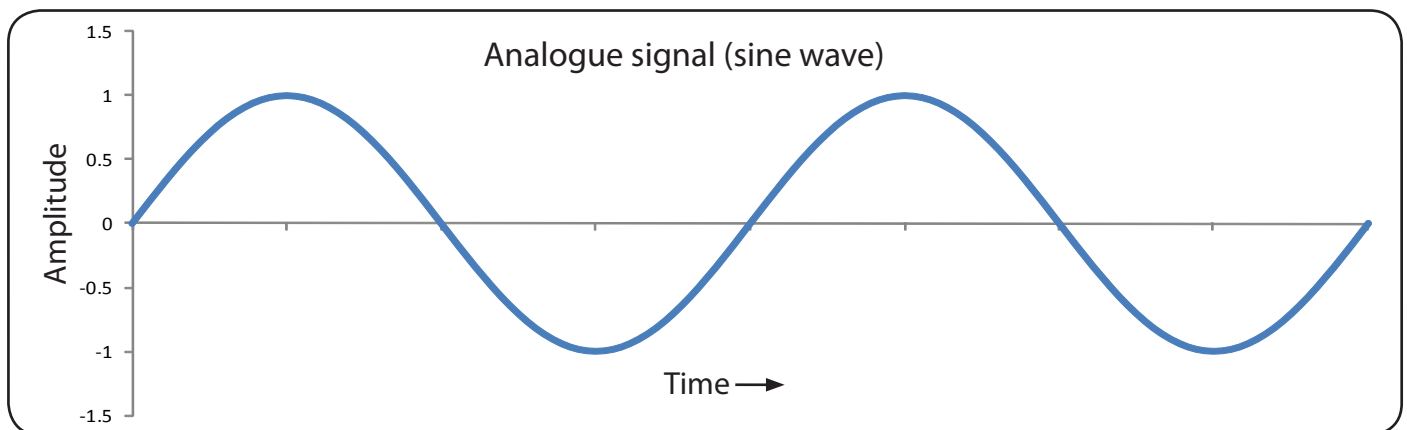

## Auto tune

Auto tune is a metal detector feature that shifts the detector's operating channel to reduce the effect of environmental noise. If an environmental noise source is operating at, or producing, harmonic frequencies that match the detector's operating channel the detector becomes susceptible to falsing. By shifting the detector's operating channel up or down the detector can avoid being affected by environmental noise. (Also see "Noise Cancel" on page 11)

## Broad Band Spectrum (BBS)

BBS is Minelab's patented multiple frequency metal detection technology. BBS transmits a broad range of 17 frequencies from 1.5 kHz to 25.5 kHz. This has the benefit of superior depth, sensitivity to small targets and accurate discrimination. BBS technology can be found in Minelab's Sovereign GT and Excalibur II metal detectors. (Also see "Full Band Spectrum (FBS)" on page 7)

## Coin, jewellery & relic hunting

Coin, jewellery & relic hunting involves detecting for coins, jewellery & relics as opposed to gold prospecting. Coin, jewellery & relic hunting metal detectors have different performance characteristics to gold prospecting detectors. Coin, jewellery & relic hunting detectors have good discrimination and can be programmed to reject specific types of metal objects or junk. They also generally come with a display pod, so a user can determine what a target might be before digging.

## Concentric coil

A Concentric coil has an inner circle and an outer circle wire winding. Its search pattern is cone shaped and can be useful for accurately pinpointing the target. Concentric coils tend to be noisier in highly mineralised ground and require more overlap of sweep for thorough ground coverage.

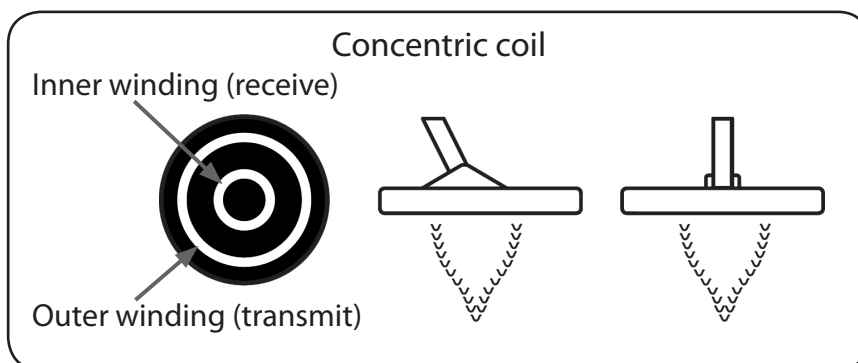

## Conductivity

Conductivity refers to how well a target allows electrical current to flow through it. In other words a highly conductive target has low electrical resistance and therefore allows current to flow more easily. Conversely a target with low conductivity has high electrical resistance and does not allow current to flow easily. (Also see "Time constant" on page 15)

## CO

CO is an abbreviation that refers to conductivity on the Smartfind display found on the Explorer SE and E-TRAC.

## Continuous wave

Continuous wave is a type of metal detecting technology. Continuous wave metal detectors create an electromagnetic field that is applied to the ground in a continuous sine wave.

## Control box

The control box encloses the electronic circuitry of the detector, that generates the Tx (transmit) signals sent by the search coil and processes the Rx (receive) signals detected by the search coil.

## Current

Current is the flow of electrical charge and is measured in Amperes (A or Amps). Current measurements are common on batteries and power supplies (i.e. AA NiMH battery: 2600 mAh, DC power supply: 1.5 A). Current is also induced into targets by the electromagnetic field produced by metal detectors, these are called eddy currents. (Also see "Voltage" on page 17)

## Depth

Depth in metal detecting terms refers to how deep a target is buried. A metal detector that can achieve greater depth is able to detect deep targets. Minelab's E-TRAC, X-TERRA and Explorer SE also have graphical depth indicators.

## Digital

Digital refers to a method of transmitting and receiving data between electronic devices or within an electronic circuit. Digital signals (or data) use only two states, high or low and generally conform to a counting method called binary. Electronic circuits that process digital signals have many advantages

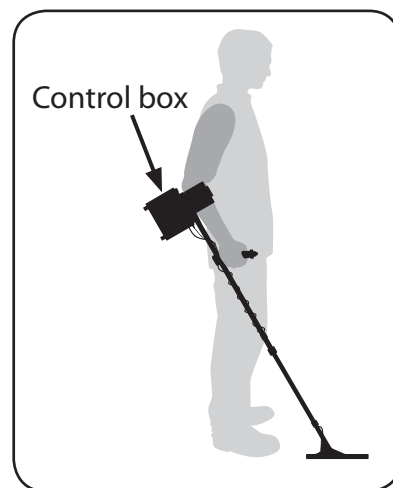

over analogue circuits, including; less susceptible to noise and interference, able to process more information, able to filter signals using less electronic components, are lighter and cheaper.

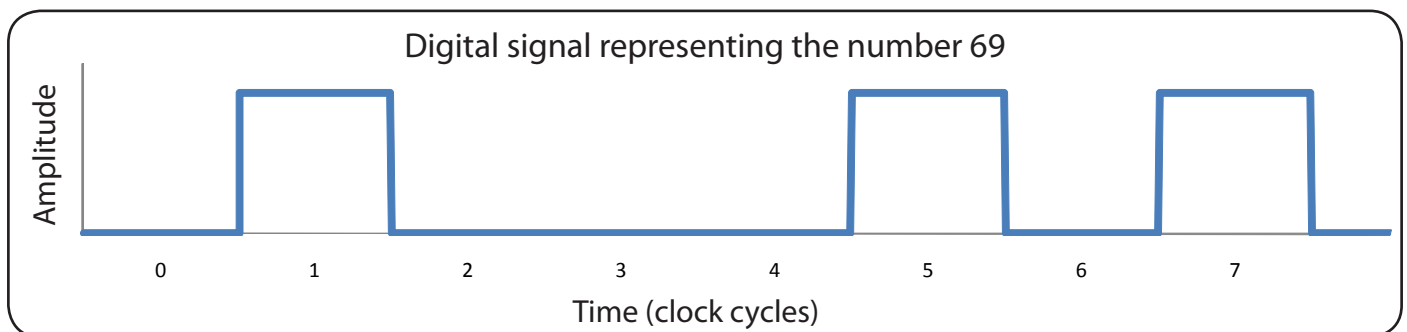

### Discrimination

Discrimination is a metal detector function that recognises the differences between various types of targets. Minelab has three different discrimination technologies; Variable discrimination, Notch filter discrimination and the most advanced, Smartfind discrimination. Smartfind discrimination can discriminate a target based on both Ferrous and Conductive properties simultaneously.

Ferrous properties refer to how much iron is in a target and therefore how strongly it's attracted to a magnet. Ferrous targets tend to be trash, so can be discriminated/masked out based on their ferrous properties alone by the detector. Conductive properties refer to how well a target conducts electrical current and therefore responds to a metal detector's electromagnetic field. Trash like nails and foil have different conductive properties to valuable targets like coins and rings. In this case the metal detector can make a judgement as to whether the target is trash based on conductivity.

### Discrimination pattern

A Discrimination pattern is a graphical representation of accepted and rejected targets based on ferrous and conductive properties. Targets with properties that appear in the shaded section are masked and targets with properties that appear in the non-shaded area are accepted. Discrimination patterns are used on Minelab's X-TERRA series (one dimensional) as well as Explorer and E-TRAC with the two dimensional Smartfind discrimination display. (Also see "Discrimination" on page 4)

### Detectorist

A detectorist is a person who regularly uses metal detectors professionally or as a hobby.

### Double-D coil (DD)

A double-D coil has two overlapping wire windings in the shape of two D's (one reversed). The characteristics of a Double-D coil are stability (especially in heavily mineralised ground), good depth and sensitivity, and a very thorough search pattern.

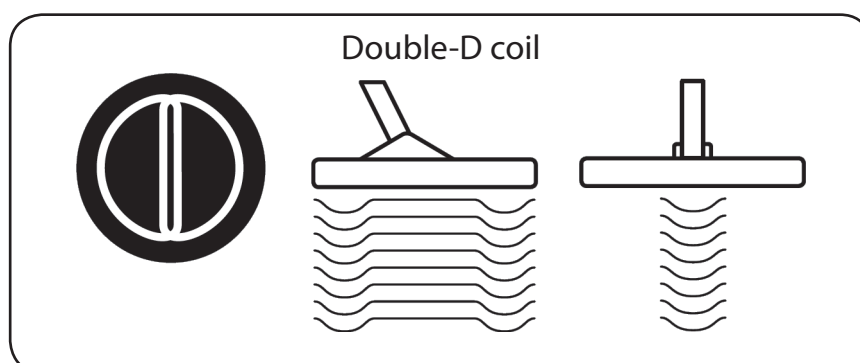

## Dual Voltage Technology (DVT)

Minelab's patented Dual Voltage technology (DVT) is implemented in the GPX series of metal detectors. DVT transmits two different voltage levels from the search coil. This has the advantage of improved ground balance, increased sensitivity to small targets and increased detection depth.

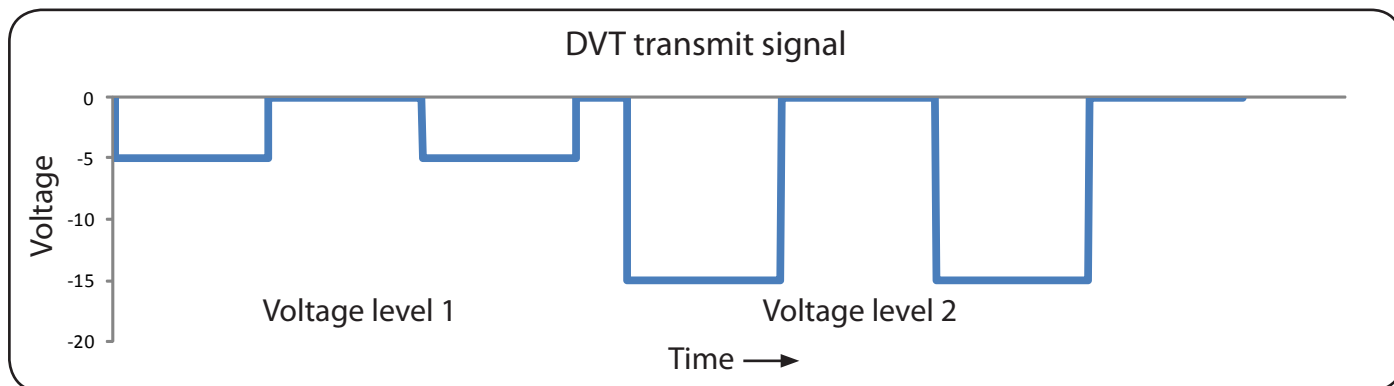

## Eddy currents

Eddy currents are tiny electrical currents that are induced into targets when a metal detector's electromagnetic field is present. These eddy currents then generate an electromagnetic field around the target which can be detected by a metal detector.

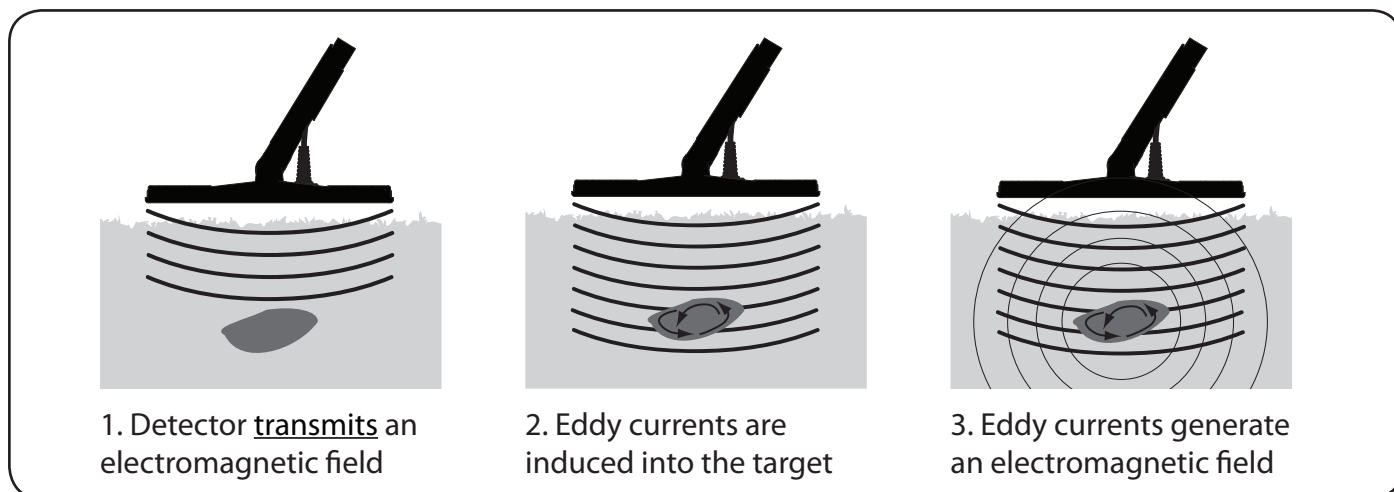

## Environmental noise

Environmental noise comes from power lines, underground cables, radar, other detectors or climatic conditions like thunder storms that produce electrical signals or noise that can interfere with a metal detector's operation.

## Electromagnetic field

An electromagnetic field is a magnetic field that has been generated electrically. Metal detectors radiate an electromagnetic field from the search coil. This influences buried targets, which then affects the signal received back by the detector.

## Falsing

Falsing occurs when a metal detector gives a detection response to electrical noise, ground noise or bumping.

## Ferrous (Fe)

Ferrous objects/targets contain iron and therefore are attracted to a magnet.

## FE

FE is an abbreviation that refers to a target's ferrous properties on the Smartfind display found on the Explorer SE Pro and E-TRAC.

## Frequency

Frequency is the number of times a signal or wave completes a full cycle per second and is measured in hertz (Hz). Frequency is also the inverse of the wave's period (i.e. frequency = 1/period)

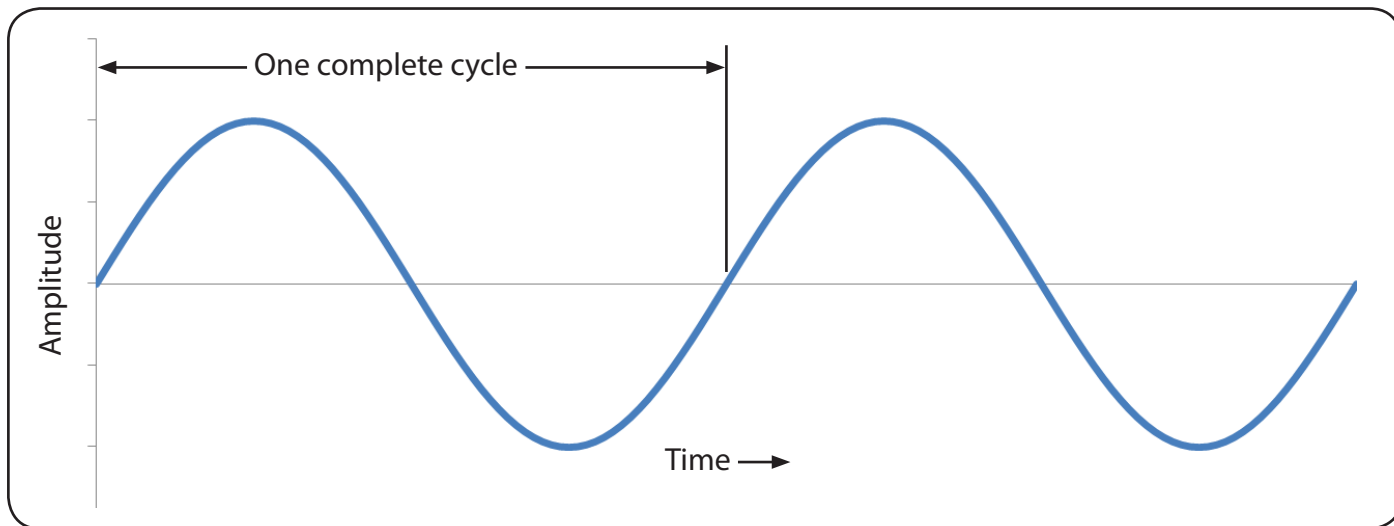

For example if a signal repeats itself 10 times every second the signal's frequency is 10 Hz.

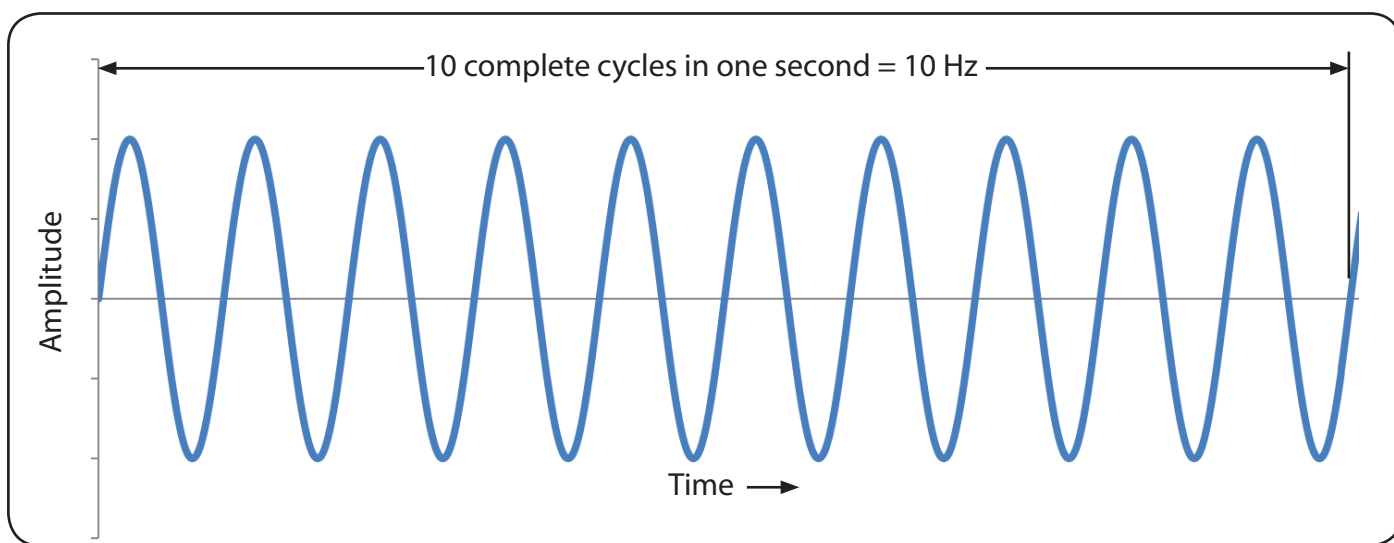

The frequency that a metal detector operates at (transmitted by the search coil) affects its performance, as a rule of thumb, the lower the frequency, the deeper it can penetrate the ground. At low frequencies however, sensitivity to small low conductive targets is reduced. The higher the frequency, the higher the sensitivity to small targets, but will not penetrate as deeply.

In general, gold detectors operate at higher frequencies (to find small nuggets), while coin and treasure detectors work at lower frequencies for deeper penetration. The exception to this is MPS type metal detectors that are sensitive and deep seeking simultaneously.

## Frequency domain

Frequency domain refers to the viewing or analysis of signals with reference to frequency, rather than time. (Also see "Time domain" on page 16)

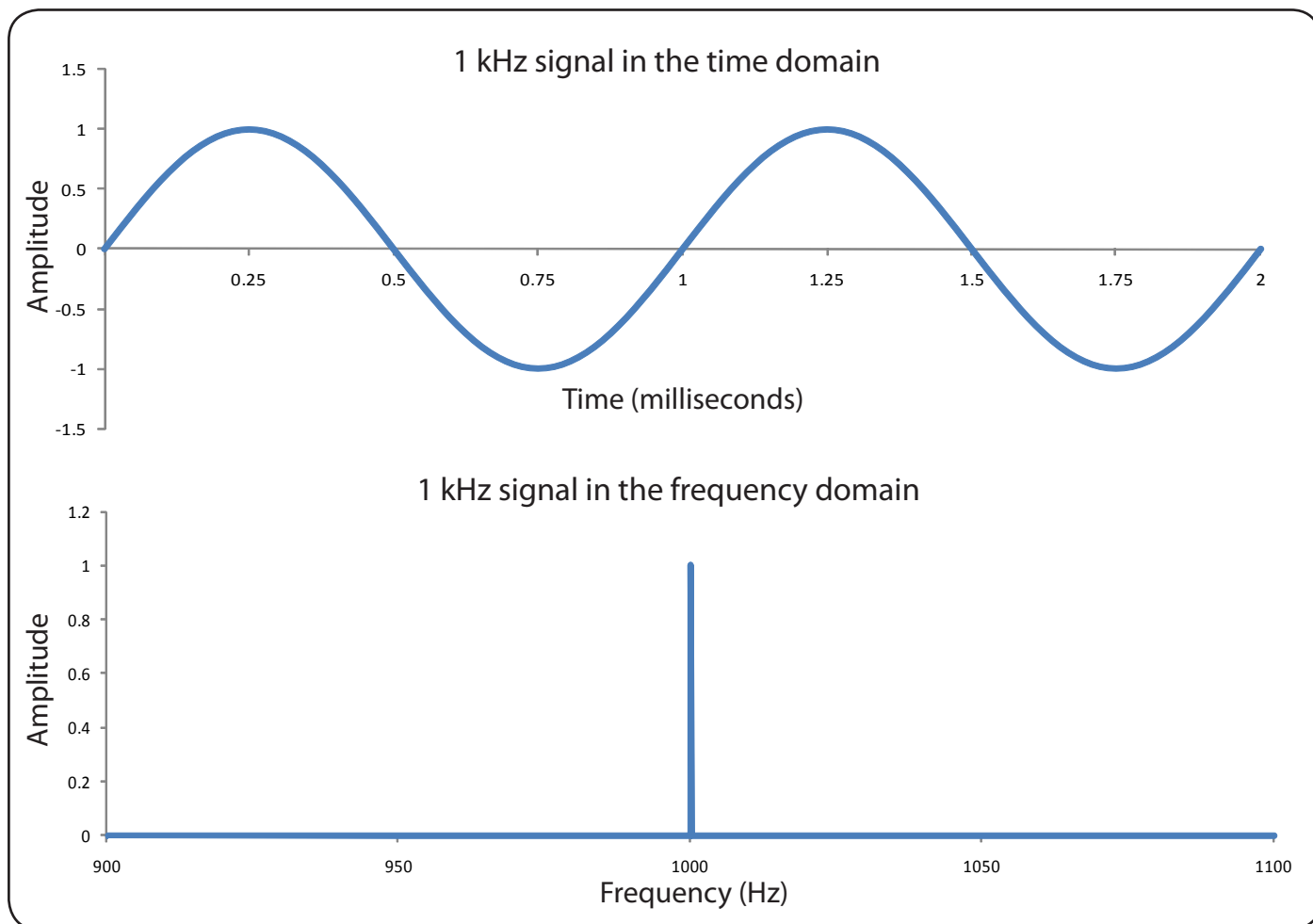

## Full Band Spectrum (FBS)

FBS is Minelab's patented multiple frequency metal detection technology. FBS transmits a broad range of 28 frequencies from 1.5 kHz to 100 kHz. This has the benefit of superior depth, sensitivity to small targets and accurate discrimination. FBS technology can be found in Minelab's E-TRAC, Explorer SE Pro and Safari metal detectors. (Also see "Broad Band Spectrum (BBS)" on page 2)

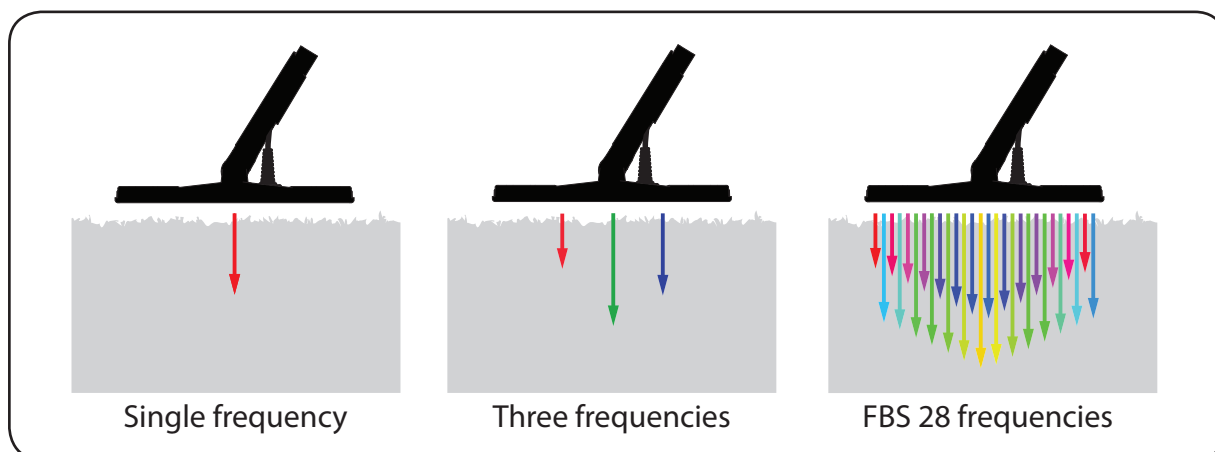

## Gold prospecting

Gold prospecting is the activity of searching for new gold. Gold prospecting metal detectors have different performance characteristics to Coin, jewellery & relic hunting metal detectors. Gold prospecting metal detectors have superior ground balancing abilities to operate in highly mineralised ground and can detect targets at greater depth.

## Ground balance

Ground balance is the ability of a metal detector to compensate for the effects of ground mineralisation. Metal detectors see mineralised ground as one huge target, which makes detecting buried targets in mineralised ground difficult. Ground balance is an important feature, because ground mineralisation impedes detection depth. The better a metal detector can ground balance, the deeper it will detect targets in mineralised ground.

## Ground mineralisation

Ground mineralisation refers to how magnetic the ground is. This doesn't mean that mineralised ground produces a magnetic field, but it does mean that particles or grains in the soil will be attracted to a magnet. Metal detectors see mineralised ground as one huge target, which makes detecting buried targets in mineralised ground difficult. Minelab invented true automatic ground balancing technology in 1987 to successfully counteract the effect of ground mineralisation.

## Ground noise

Ground noise is the false signalling caused by a metal detector that is not ground balanced to the soil. The ground noise occurs when the unbalanced detector's search coil is swept across ground that varies in mineralisation, soil type, rocks or has dips and holes.

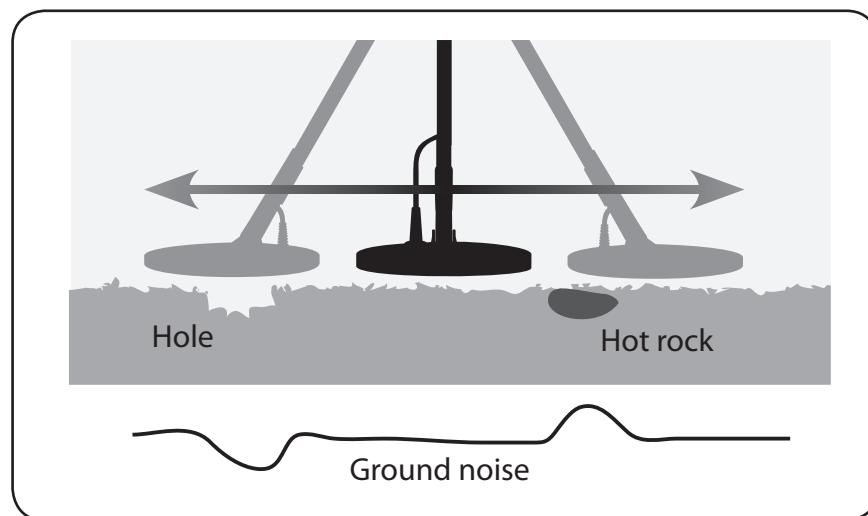

## Ground tracking

Ground tracking refers to the ability of the detector to track changes in ground mineralisation and automatically adjust the ground balance to suit. This ensures continuous ground balance and full detection depth, eliminating the need for the operator to stop and manually adjust the detector as ground conditions change.

## Halo effect

Halo effect occurs after a target has remained undisturbed in the ground for a considerable amount of time. As the target breaks down or rusts the soil immediately around it becomes highly mineralised. A detector will see this area of high mineralisation and give a detection response indicating that the target is larger than it really is.



## Harmonic frequencies (harmonics)

Harmonic frequencies are components of a signal or wave that are multiples of the fundamental frequency. For example a 15 kHz signal will have harmonic frequencies at 30 kHz, 45 kHz, 60 kHz, 75 kHz and so on. These harmonic frequencies reduce in magnitude as they get further and further away from the fundamental frequency of 15 kHz. Harmonic frequencies are best viewed in the frequency domain.

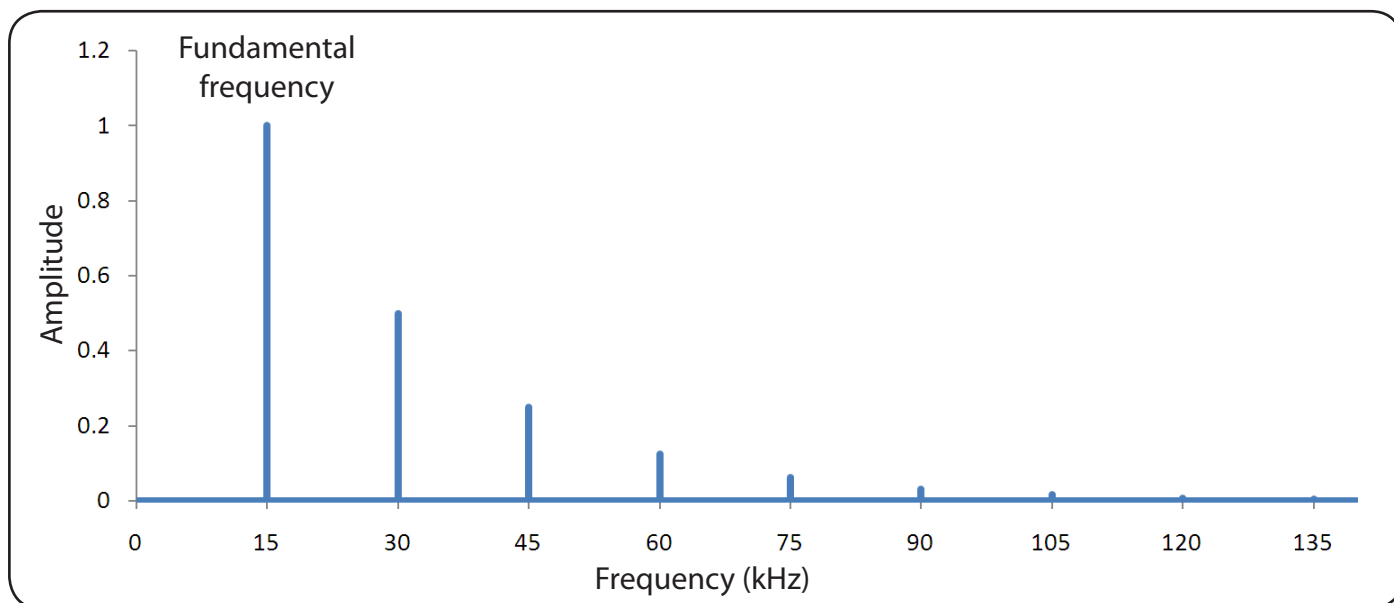

## Hot rocks

Hot rocks are rocks that are mineralised differently to their surrounding ground. For example a highly mineralised rock buried in mildly mineralised ground would be considered to be a hot rock. However, a highly mineralised rock in an equally highly mineralised ground would not be considered to be a hot rock. (Also see Ground mineralisation)

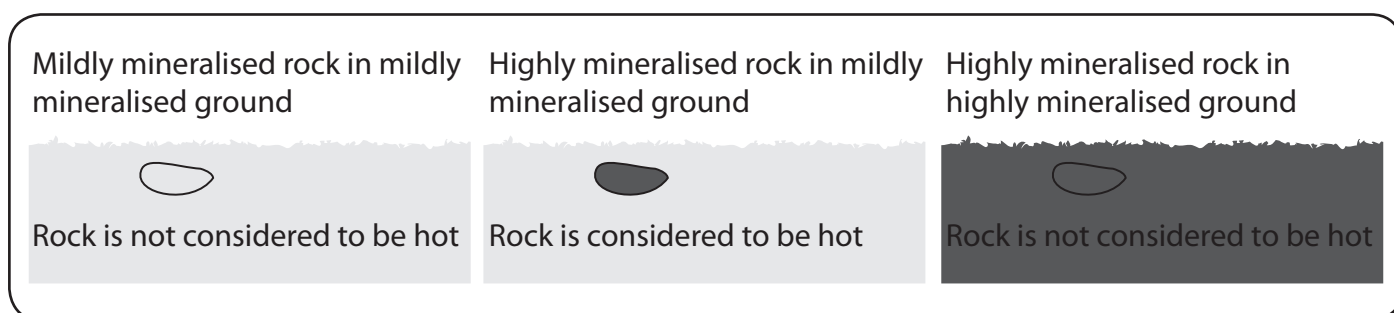

## Iron Mask

Iron mask refers to operating a metal detector with iron masked or discriminated. Only non-ferrous metals containing little or no iron will be detected.

## Junk

Junk (or trash) refers to unwanted ferrous or non-ferrous metal targets. Nails, paperclips and wire are examples of ferrous junk and bottle tops, ring pulls and foil are examples of non-ferrous junk. Junk is often buried amongst valuable targets like coins. To solve this, Minelab has a range of metal detectors with the ability to 'discriminate' whether a target is likely to be treasure or trash based on both ferrous and conductive properties.

### Lithium-ion battery (Li-ion battery)

Lithium-ion batteries are a new type of rechargeable battery that has advantages over older rechargeable battery technologies like nickel-metal hydride (NiMH), nickel cadmium (NiCd) and sealed lead acid (SLA). Lithium-ion batteries are lighter, have no memory effect and a low self discharge rate.

### Monoloop coil

Monoloop coils are a special style of coil for MPS technology detectors (SD & GPX Series). These coils have one winding of wire around the circumference of the coil, which is used to both transmit and receive. The signal pattern of the Monoloop coil is cone shaped, requiring more overlapping. In extremely heavily mineralised grounds they can be more difficult to ground balance, however they tend to provide slightly better depth than the Double D coils.

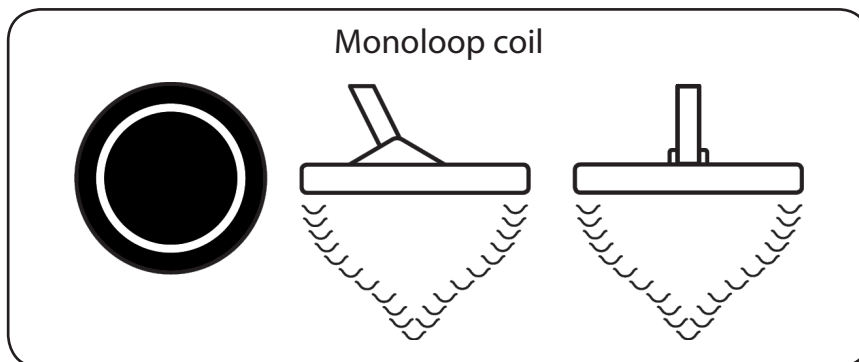

### Multi-frequency

Multi-frequency is a type of metal detector technology that uses more than one frequency. Single frequency metal detectors can be limited due to their fixed frequency. This is because lower frequencies detect deeper into the ground, but higher frequencies detect smaller targets. By combining multiple frequencies into one detector, depth and sensitivity to small targets is achieved. (Also see "Broad Band Spectrum (BBS)" on page 2 & "Full Band Spectrum (FBS)" on page 7)

### Multi Period Sensing (MPS)

Multi period sensing is Minelab's patented pulse induction technology first released in Minelab's SD2000 detector in 1995. Standard pulse induction metal detectors are limited due to their single pulse width. MPS uses varying pulse widths that extract more information from targets, achieve better ground balance, remove ground noise and detect to greater depths. (Also see "Dual Voltage Technology (DVT)" on page 5)

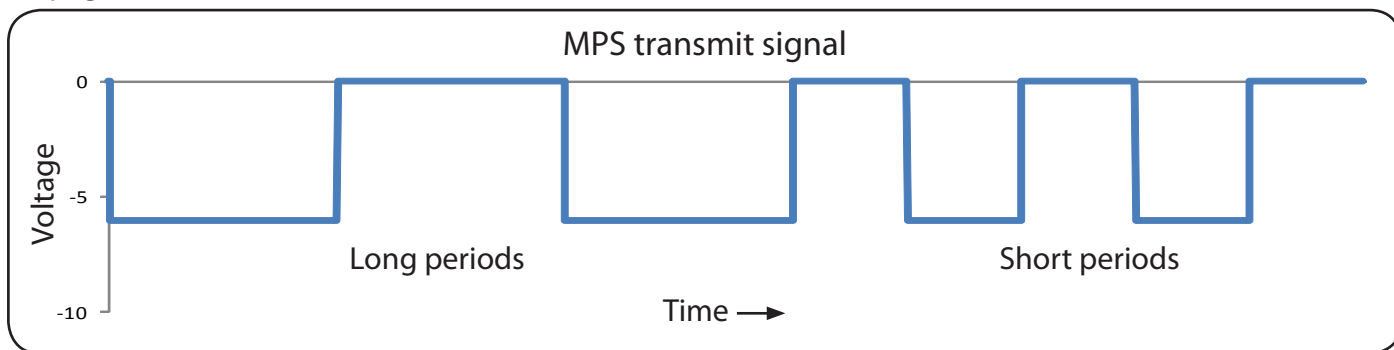

### Nickel cadmium battery (NiCd)

Nickel cadmium batteries are rechargeable batteries. They are available in common battery sizes such as AA, C, and D, however at 1.2 volts they have a slightly lower cell voltage than alkaline and carbon zinc batteries. NiCds have high discharge current capabilities due to their low internal resistance, but suffer from memory effect and have a relatively high self discharge rate (will discharge themselves over about ten weeks).

### Nickel metal hydride battery (NiMH)

Nickel metal hydride batteries are rechargeable batteries, which have advantages over NiCd batteries. NiMH provide 1.2 volts per cell, but do not suffer from a memory effect and are capable of higher energy densities than NiCd batteries.

### Noise Cancel

Noise cancel is a metal detector feature that automatically shifts the detector's operating frequency or frequencies to reduce the effect of environmental noise. If an environmental noise source is operating at or producing harmonic frequencies that match one or more of a detector's frequencies then the detector becomes susceptible to falsing. By shifting the detector's frequency up or down the detector can avoid being affected by environmental noise. (Also see "Auto tune" on page 2)

### Non-ferrous

Non-ferrous materials do not contain iron and are not attracted to a magnet. (Also see Ferrous)

### Notch Filter Discrimination

Notch filter discrimination is the ability of a metal detector to select which of the conductivity segments in the discrimination scale are active or disabled. If a segment is notched out then metals with that level of conductivity will be masked and not produce a response.

### Ohm

Ohm is a unit of measure of electrical resistance (symbol  $\Omega$ ). Resistance measurements are common on headphones and speakers. (Also see "Voltage" on page 17 & "Current" on page 3)

### Period

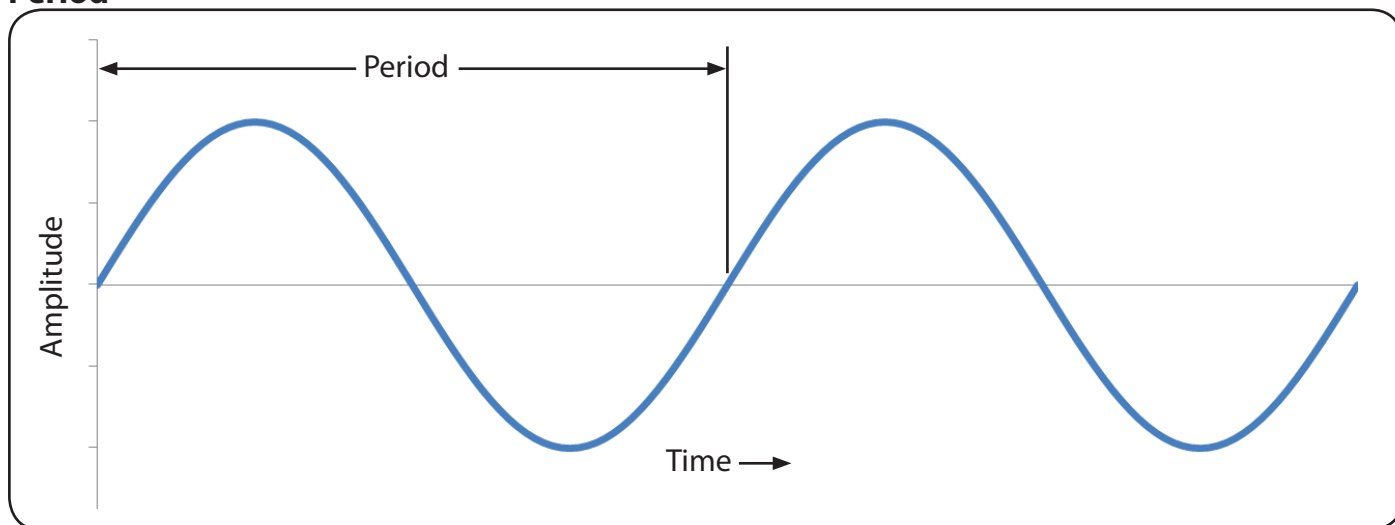

Period is the time it takes for a wave or signal to complete one cycle. The period is also the inverse of the wave's frequency. (i.e.  $\text{period} = 1/\text{frequency}$ )

### Pinpointing

Pinpointing is the activity of narrowing down the location of a buried target. Many of Minelab's detectors have a pinpointing mode that allows the user to determine the exact location of a target before digging. The process involves putting the detector into pinpoint mode and slowly sweeping the ground above the target to find the strongest response, then turning 90° and sweeping again to get an accurate target location.

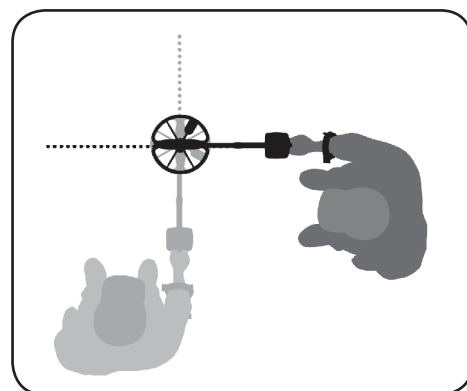

### Pulse Induction (PI)

Pulse Induction (PI) is a type of metal detecting technology. Pulse induction operates by sending short pulses of voltage to the metal detectors coil. These short pulses cause a magnetic field to be generated which quickly dissipates at the end of each pulse. Any metal targets that induce the magnetic field remain magnetised for a short time after the end of a pulse. The target's decaying magnetism is then detected by the detector's coil. (Also see "Multi Period Sensing (MPS)" on page 10 & "Dual Voltage Technology (DVT)" on page 5)

### QuickMask

QuickMask is a feature available on Minelab's E-TRAC. Quickmask allows a user to quickly edit and customise a discrimination pattern.

### Receive (Rx)

Receive is the process of collecting a signal or magnetic field by the metal detector's search coil.

### Resistance

Resistance is the opposition to current flowing in an electrical conductor and is measured in Ohms ( $\Omega$ ).

### Sealed lead acid battery (SLA)

Sealed lead acid batteries are rechargeable batteries. They come in a wide variety of sizes and are most often packaged in 6 volt or 12 volt packs. SLA batteries have high discharge current capabilities due to their low internal resistance.

### Search Coil (loop)

The search coil is the circular or elliptical plate that is swept above the ground during detecting. It transmits electromagnetic signals into the ground and receives the response. The word coil actually refers to the wire windings inside the housing, which can take different forms and shapes. For more information on the different types of coils see Concentric coil, Double-D coil and Monoloop coil.

### Sensitivity

Sensitivity refers to how responsive a metal detector is to small or deep targets.

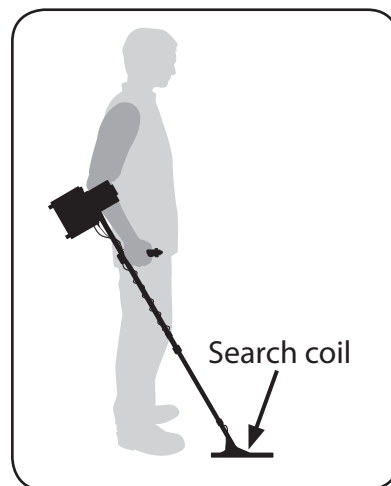

### SETA

SETA is an acronym for Smart Electronic Timing Alignment. SETA technology enables a detector with multiple timings to individually and automatically align each channel in a way that is not possible with manual adjustments. This results in reduced noise and interference, improving sensitivity, ground balancing and detection depth across all timings.

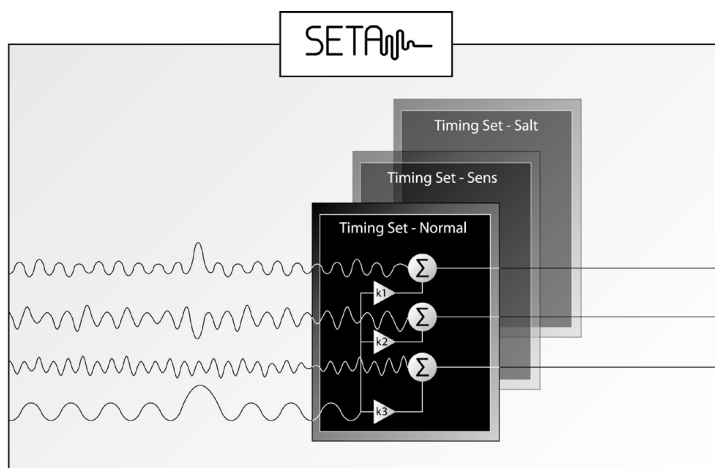

## Signal

Signal in metal detecting terms refers to both the transmitted magnetic field from the detectors search coil and the received magnetic field from a metal target.

## Sine wave

A sine wave or sinusoid is the name of a waveform that mathematically corresponds to the sine function  $[y(t) = A \cdot \sin(\omega t + \theta)]$ . A pure electrical sine wave does not produce harmonic frequencies.

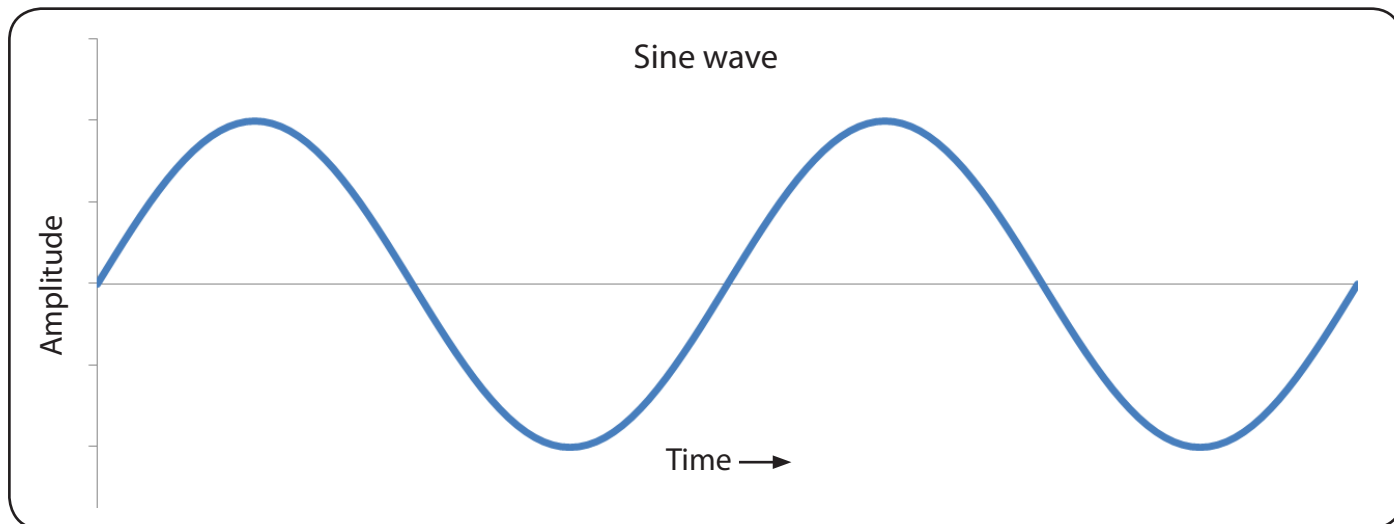

## Smartfind Discrimination

Smartfind is Minelab's unique two dimensional scale of discrimination. Smartfind graphically represents a target's ferrous and conductive properties on the same display.

Smartfind is a feature of two Minelab metal detectors; E-TRAC and Explorer SE Pro.

E-TRAC Smartfind:

The horizontal axis rates the target on its size/conductivity (CO), ranging 1–50 from left to right.

The vertical axis rates the extent of the target's ferrous characteristics (FE), ranging 1–35 from top to bottom. A FE value of 1 represents low ferrous characteristics and a value of 35 represents high ferrous characteristics. Similarly, a CO value of 1 represents low conductivity and 50 represents high conductivity.

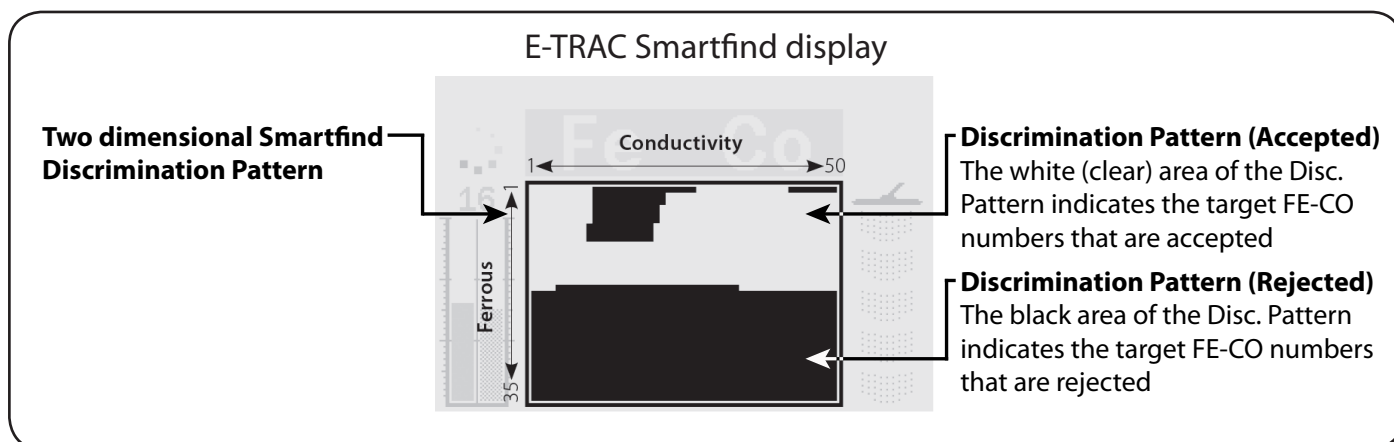

Explorer SE Pro Smartfind:

The vertical axis rates the target on its size/conductivity (CO), ranging 0–31 from bottom to top. The horizontal axis rates the extent of the target's ferrous characteristics (FE), ranging 0–31 from right to

left. A FE value of 0 represents low ferrous characteristics and a value of 31 represents high ferrous characteristics. Similarly, a CO value of 0 represents low conductivity and 31 represents high conductivity.

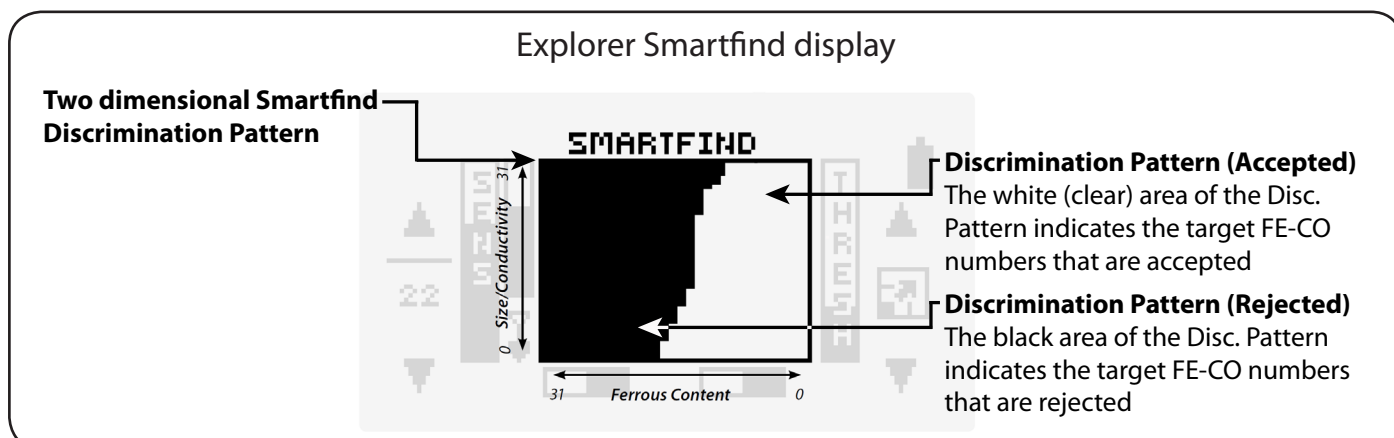

### Square Wave

A square wave is the name given to a waveform that has rapid transitions from one state to another. Square waves are used in electronics as clock signals, timing pulses and control signals. Square waves generate many harmonic frequencies.

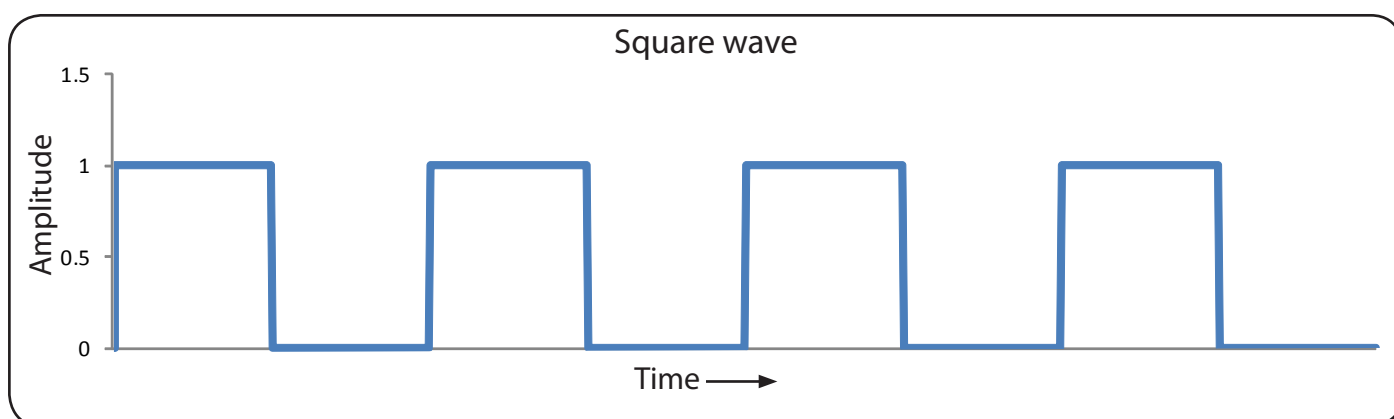

### Target

Target refers to any buried metal object that can be detected by a metal detector. A target can be either valuable coins or junk like bottle tops. The term does not refer to the value of the buried object.

### Target ID number

Target ID numbers are numbers that identify targets based on ferrous and/or conductive properties. The table below shows some typical target IDs from an X-TERRA 305.

Target	Target ID
US Quarter	44
Australian \$1 coin	32
Ring pull	12
Wedding ring	8
Long screw	-4
Short screw	-4
Paper clip	-4

## Threshold

Threshold is the continuous audible level of sound emitted by the detector. The threshold can be set anywhere between silent and loud; but a soft audible level is normally suggested.

When the Threshold is too high a faint signal is masked and only the peak of the loud signal is audible above the Threshold.

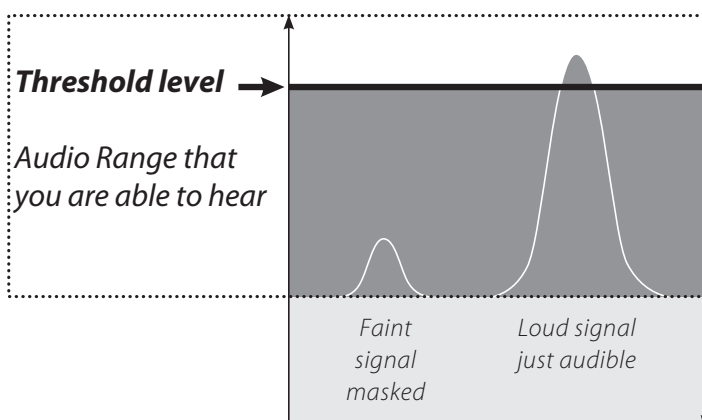

With the Threshold set correctly both target signals are easily heard.

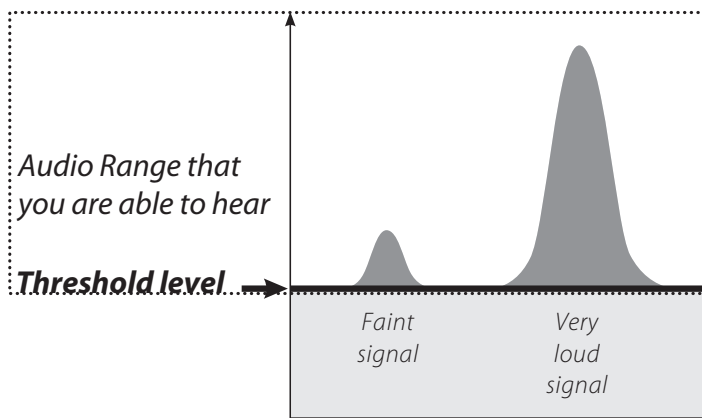

A Threshold level that is too low does not allow faint target signals to be heard.

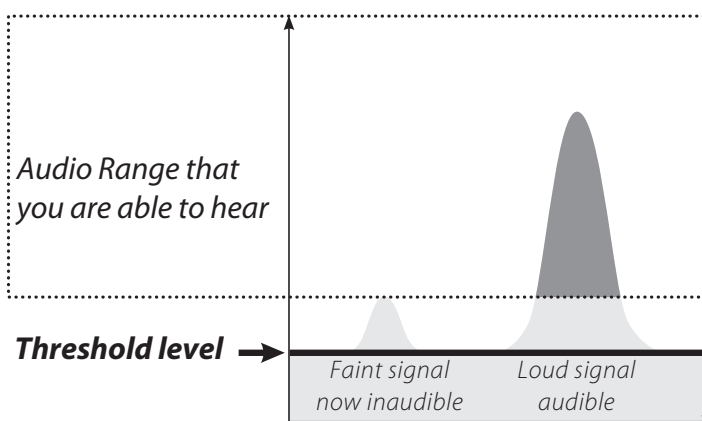

## Time constant

Time constant is a measure of a target's combined conductivity and inductance. A target with high conductivity (low resistance) and high inductance will have a long time constant (i.e. gold ingot). A target with low conductivity (high resistance) and low inductance will have a short time constant (i.e. fine jewellery). Minelab metal detectors are capable of detecting the full range of time constants.

## Time domain

Time domain refers to the viewing or analysis of signals with reference to time, rather than frequency. (Also see "Frequency domain" on page 7)

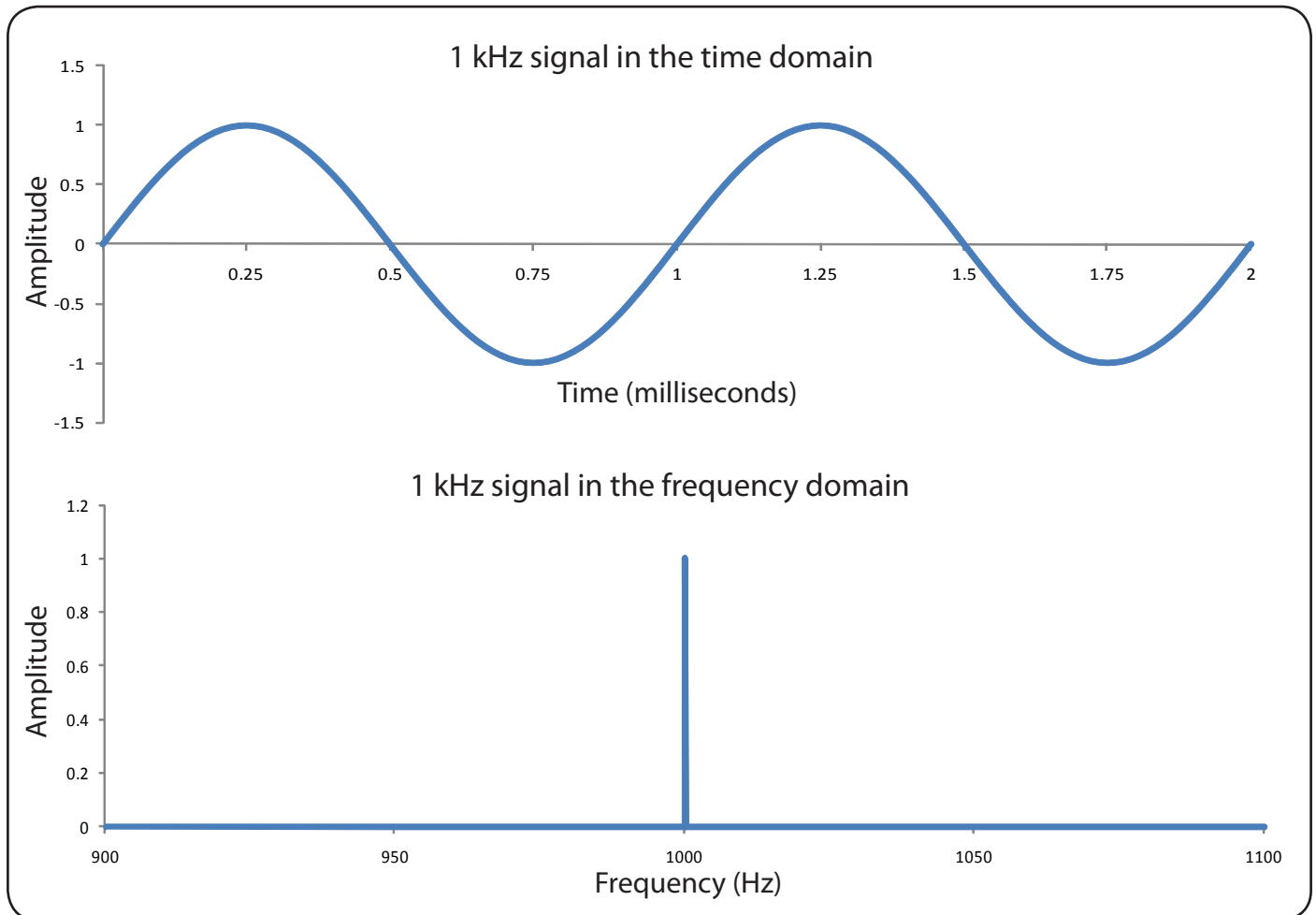

## Timings

Timings refer to the digital switching rates that control the internal electronics of the detector. In the GPX series of detectors the timings generate a pulse train to create the transmit waveform. The same timings generate synchronised switching signals to control the receive electronics.

Selecting different timings and thus changing both the transmit waveform and synchronised receive switching signals have benefits for different ground types and targets. Minelab has created a range of different timings in the GPX series of detectors that achieve optimum depth, sensitivity and ground balancing across different detecting conditions. (Also see "Multi Period Sensing (MPS)" on page 10, "Dual Voltage Technology (DVT)" on page 5 & "SETA" on page 12)

## Tone identification

Tone identification is similar to target ID numbers; however, instead of using displayed numbers different tones are associated to different target IDs.

## Transmit (Tx)

Transmit is the process of sending a signal or magnetic field from the metal detector's search coil.

## Trashy ground

Trashy ground is ground that has high levels of junk.



**Universal Serial Bus (USB) port**

A Universal Serial Bus is a type of computer data port. Minelab's E-TRAC has a USB port that enables it to communicate with a PC to upload and download settings and discrimination patterns.

**VFLEX**

VFLEX is Minelab's metal detecting technology used in the X-TERRA range of detectors. VFLEX uses state of the art digital electronics to enhance standard single frequency detection technology. This has the advantage of providing dependable performance and improved immunity to outside interference. VFLEX technology also has an added advantage that changing the detector's coil also automatically changes the detector's operating frequency. This means that an X-TERRA detector can operate at different frequencies allowing the detector to be easily modified to suit different detecting conditions.

**VLF (Very low frequency)**

VLF is a type of metal detecting technology. VLF metal detectors create an electromagnetic field that is applied to the ground in a continuous sine wave.

**Voltage**

Voltage is electrical potential and is measured in volts (symbol v). Voltage measurements are common on batteries and power supplies (i.e. AA NiMH battery: 1.2 v, DC power supply: 12v). Voltage is used to energise a metal detector's search coil, which in turn generates the electromagnetic field. (See also "Current" on page 3 & "Resistance" on page 12)